



Transportation and Inequity

Beth Osborne, T4America Director

T4America.org
@t4america





 **Transportation
for America**



rtation
ica

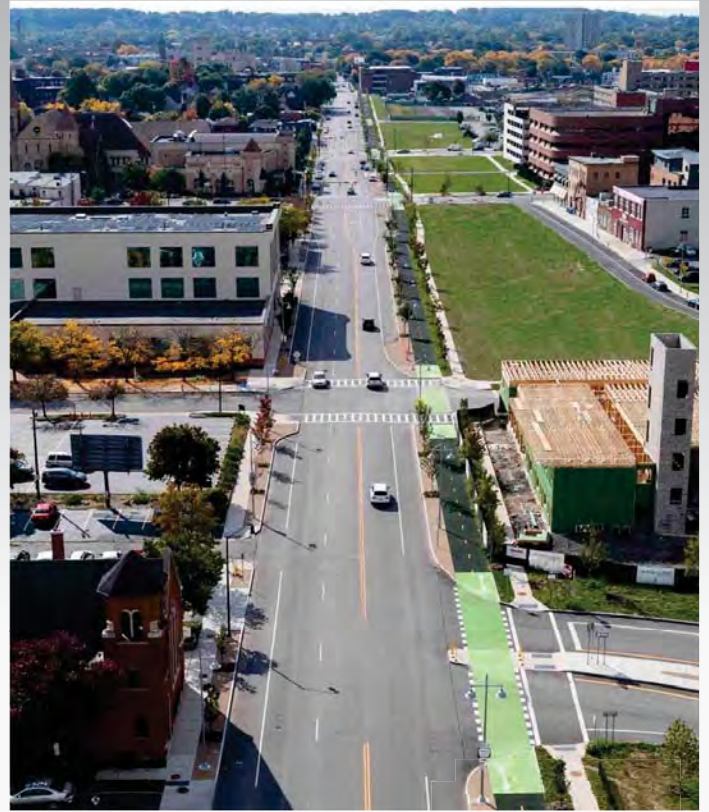

CITY	NEIGHBORHOOD	HIGHWAY
Akron, OH	Shelbondy Hill (Lane-Wooster)	I-76/I-77
Atlanta, GA	Mechanicsville	I-20
Atlanta, GA	Old Fourth Ward	Freedom Parkway (never built)
Baltimore, MD	Harlem Park	I-70 (never built)
Baton Rouge, LA	Old South Baton Rouge	I-10
Birmingham, AL	East	I-20/I-59
Charlotte, NC	Brooklyn	I-277
Chicago, IL	Southside	I-90/I-94
Cincinnati, OH	West End	I-75
Columbus, OH	Near East Side	I-71 and I-70

Columbus, OH	Mt. Vernon	I-71 and I-670
Dallas, TX	Tenth Street	I-35E
Dallas, TX	Oak Cliff	I-35E
Dallas, TX	Freedman's Town	US 75/I-345
Dallas, TX	Lincoln Manor	US 175
Dallas, TX	Bonton	US 175
Dallas, TX	Little Mexico	I-345
Denver, CO	Elyria-Swansea	I-70
Denver, CO	Globeville	I-25 and I-70
Detroit, MI	Black Bottom	I-75
Detroit, MI	Paradise Valley	I-375



Durham, NC	Hayti	SR 147 (former I-40)
Indianapolis, IN	Northwest	I-65
Lansing, MI	Near South	I-496
Little Rock, AR	Ninth Street	I-630
Los Angeles	East LA	multiple freeways
Los Angeles	South Central	I-105
Macon, Ga	Pleasant Hill	I-16/I-75
Miami, FL	Overtown	I-95
Milwaukee, WI	Bronzeville	I-43
Montgomery, AL	Centennial Hill	I-65/I-85
Montgomery, AL	Bel Air	I-65/I-85



Montgomery, AL	The Bottoms	I-65/I-85
Nashville, TN	North Nashville	I-40
New Orleans, LA	N. Claiborne Ave.	I-10
Oakland, CA	West Oakland	I-880 and I-980
Oklahoma City, OK	Deep Deuce	I-235
Omaha, NE	North Omaha	US 75
Orlando, FL	Parramore	I-43
Pittsburgh, PA	Hill District	I-579
Portland, OR	Albina	I-5
Richmond, Va	Carver	I-95
St. Louis, MO	Riverfront	I-70



St. Paul, MN	Rondo	I-94
Shreveport, LA	Allendale	I-49 (proposed)
Spokane, WA	East Central	I-90
Syracuse, NY	15th Ward	I-81
Tulsa, OK	Greenwood	I-244/I-444
Waco, TX	Northeast/Riverside	I-35
Washington, Dc	Southwest	I-395
Winston-Salem, NC	Reynoldstown	I-40



Roadway design produces danger

- ① Design can be more influential on behavior than speed limits.
- ② Other streets regularly intersect Union, but lack crosswalks or signals, because keeping vehicles from stopping (speed) is prioritized ahead of providing frequent crossings (safety).
- ③ Numerous destinations means that more people will be present.
- ④ Marked, signalized crosswalks are located as much as 0.4 miles apart, potentially requiring a 10-minute round trip to reach a destination that's directly across the street.
- ⑤ Sidewalks exist, but as an afterthought.

Photos by Forever Ready Productions



60 percent of all 2020 deaths occurred on non-interstate arterial highways like this one in Memphis, TN.

Design for Vehicle Speed

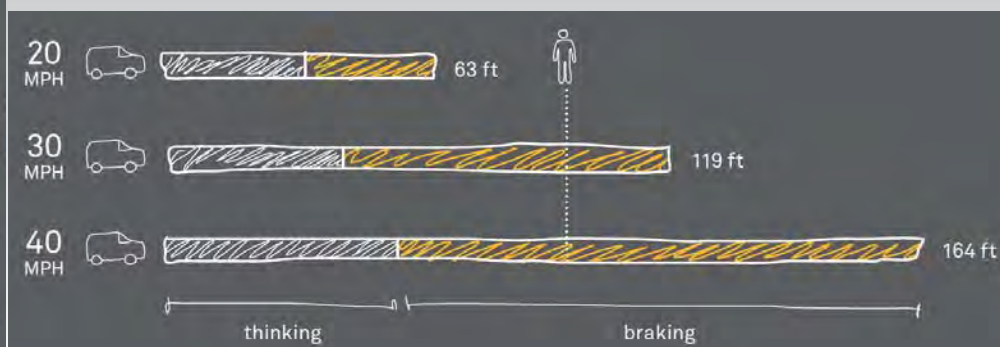
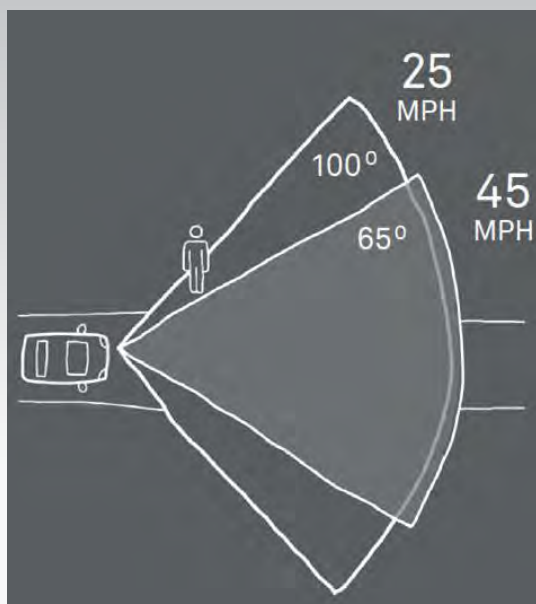

2009-2020: historic increase in fatalities

- **62% increase** in people struck and killed while walking between 2009-2020.
- **6,529 people** were struck and killed while walking in 2020
- Preliminary 2021 estimates suggest the **highest number in 40 years.**
- **Black and Native Americans** are significantly more likely to be killed.

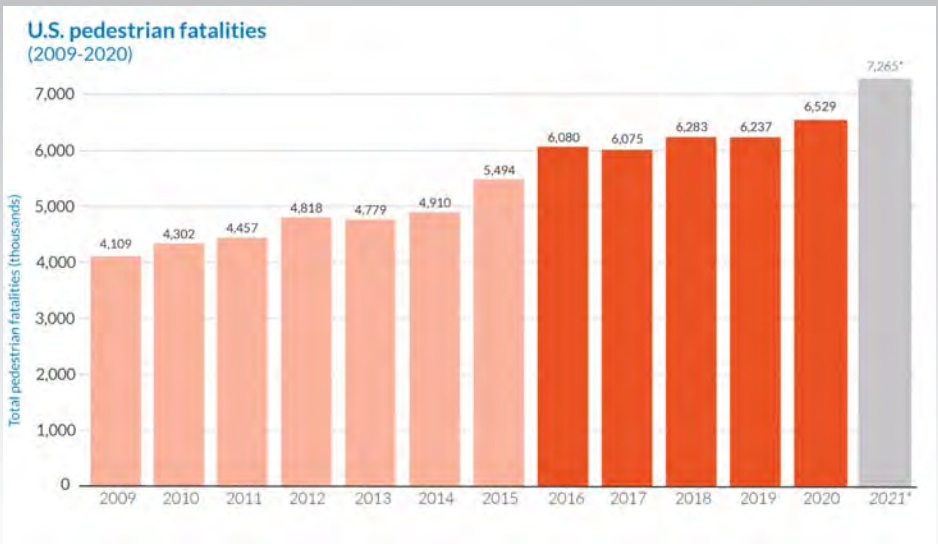

Most dangerous metros trending more deadly

THE TOP 20 Most dangerous metropolitan areas for pedestrians (2016-2020)

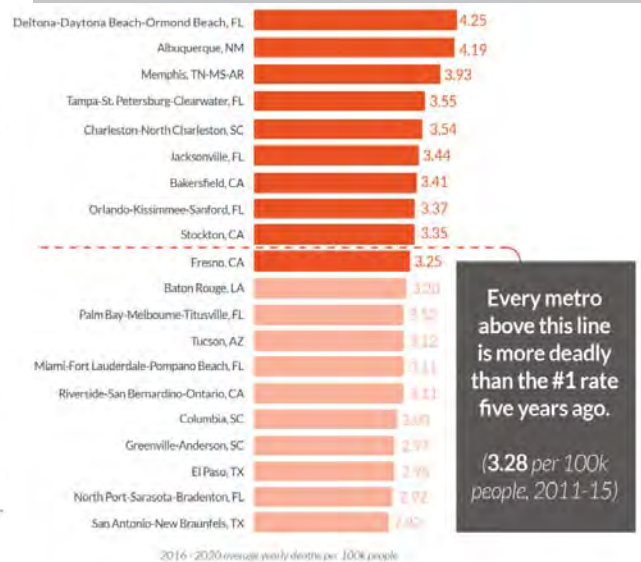

Most dangerous states trendly more deadly

THE TOP 20
Most dangerous states for pedestrians (2016-2020)

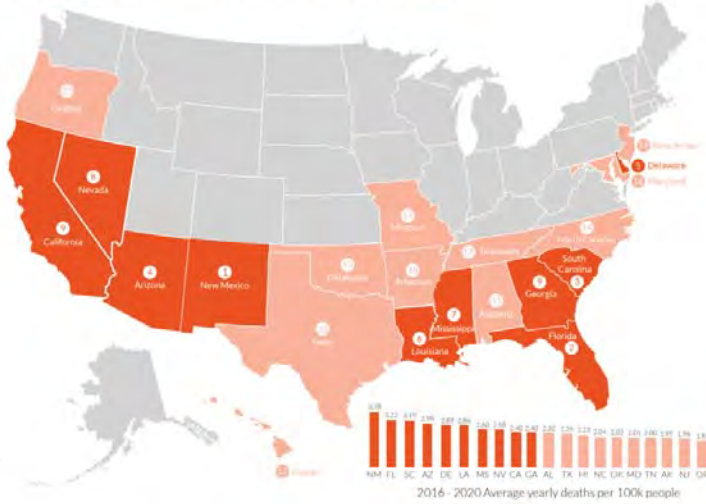

No states in the top 20 are improving
All have gotten significantly more deadly

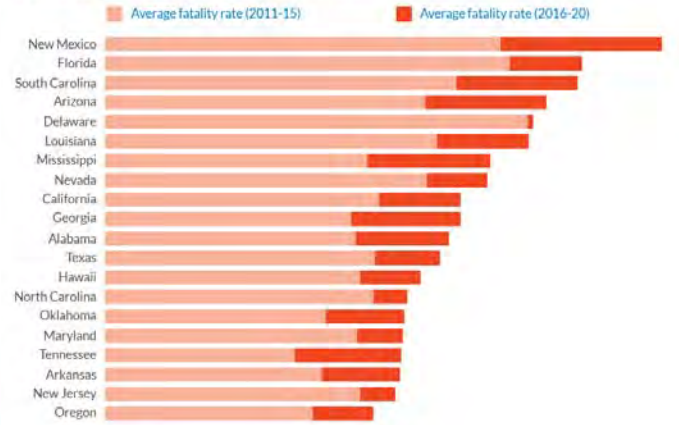

People of color more likely to die when walking

Pedestrian deaths per 100,000 by race & ethnicity (2016-2020)

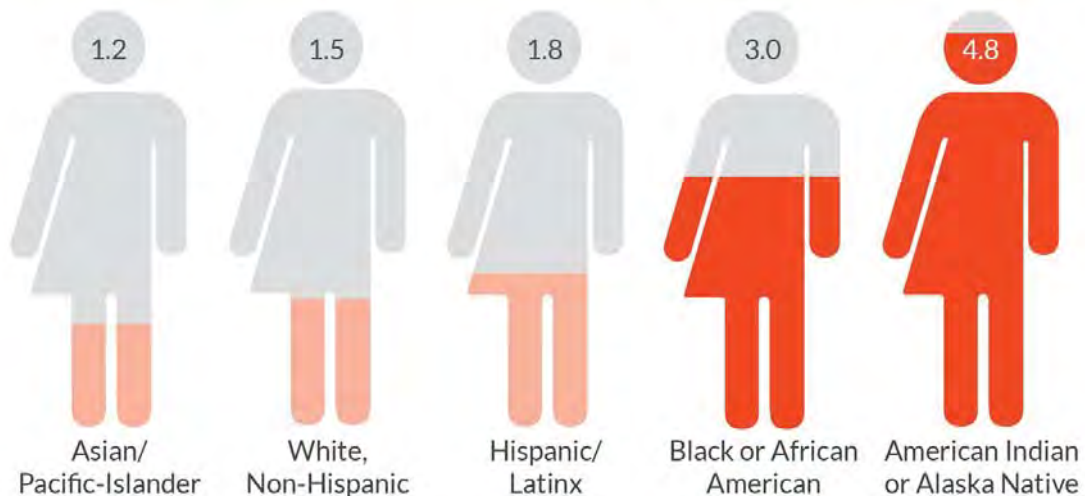

People walking in lower-income areas are killed at far higher rates

Pedestrian fatalities per 100,000 people by census tract income

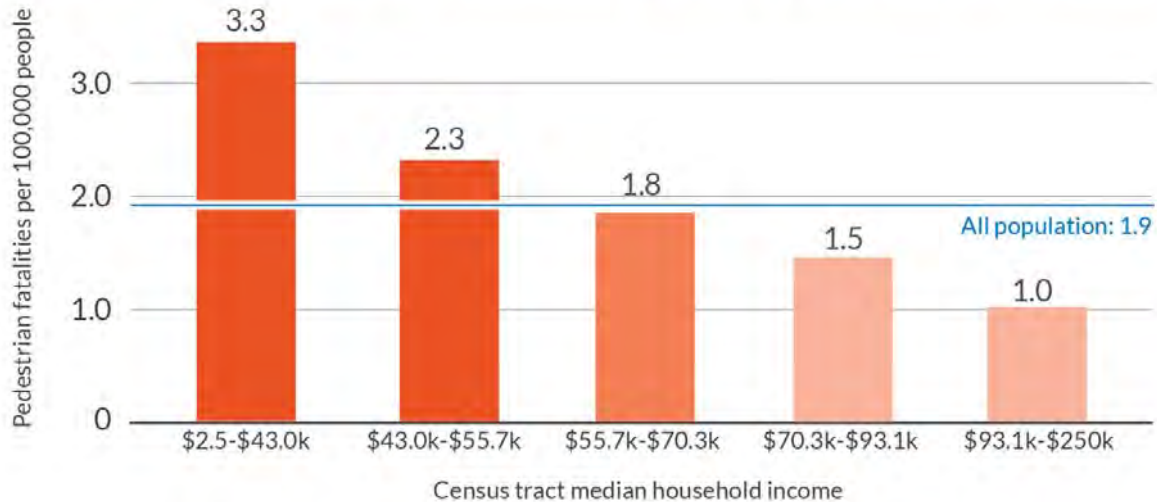

National Equity Atlas

Percent of households without a vehicle by race/ethnicity: United States; Year: 2019

SELECT BREAKDOWN FILTERS: YEAR

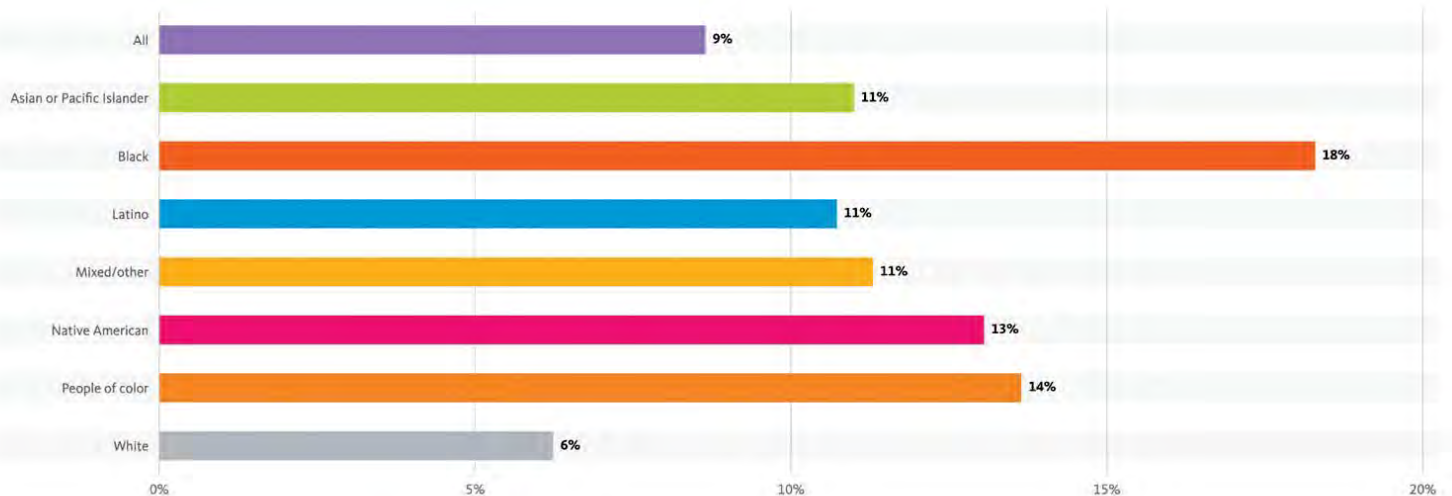

How fast can you drive here?



How fast can you drive here?



2:00 AM

8:00 AM

Noon

5:00 PM

Capital Beltway Outer Lp
 Annandale, Virginia
 Google

3443 14th St NW
 Washington, District of Columbia
 Google
 Street View - Nov 2021



FREE FLOW Low volumes and no delays.	LOS A	
STABLE FLOW Speeds restricted by travel conditions, minor delays.	LOS B	
STABLE FLOW Speeds and maneuverability closely controlled because of higher volumes.	LOS C	
STABLE FLOW Speeds considerably affected by change in operation conditions. High density traffic restricts maneuverability; volume near capacity.	LOS D	
UNSTABLE FLOW Low speeds; considerable delay; volume at or slightly over capacity.	LOS E	
FORCED FLOW Very low speeds; volumes exceed capacity; long delays with stop-and-go traffic.	LOS F	

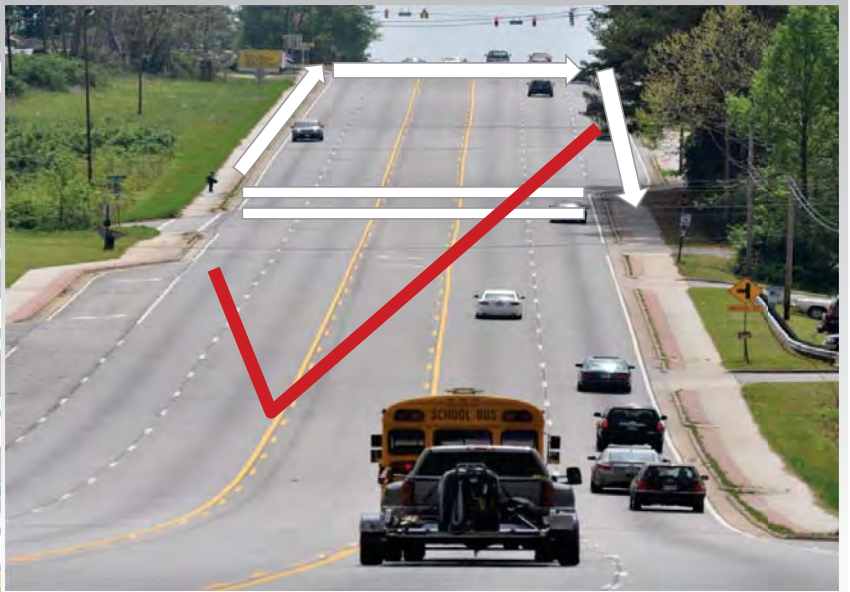

Designing for Peak Usage

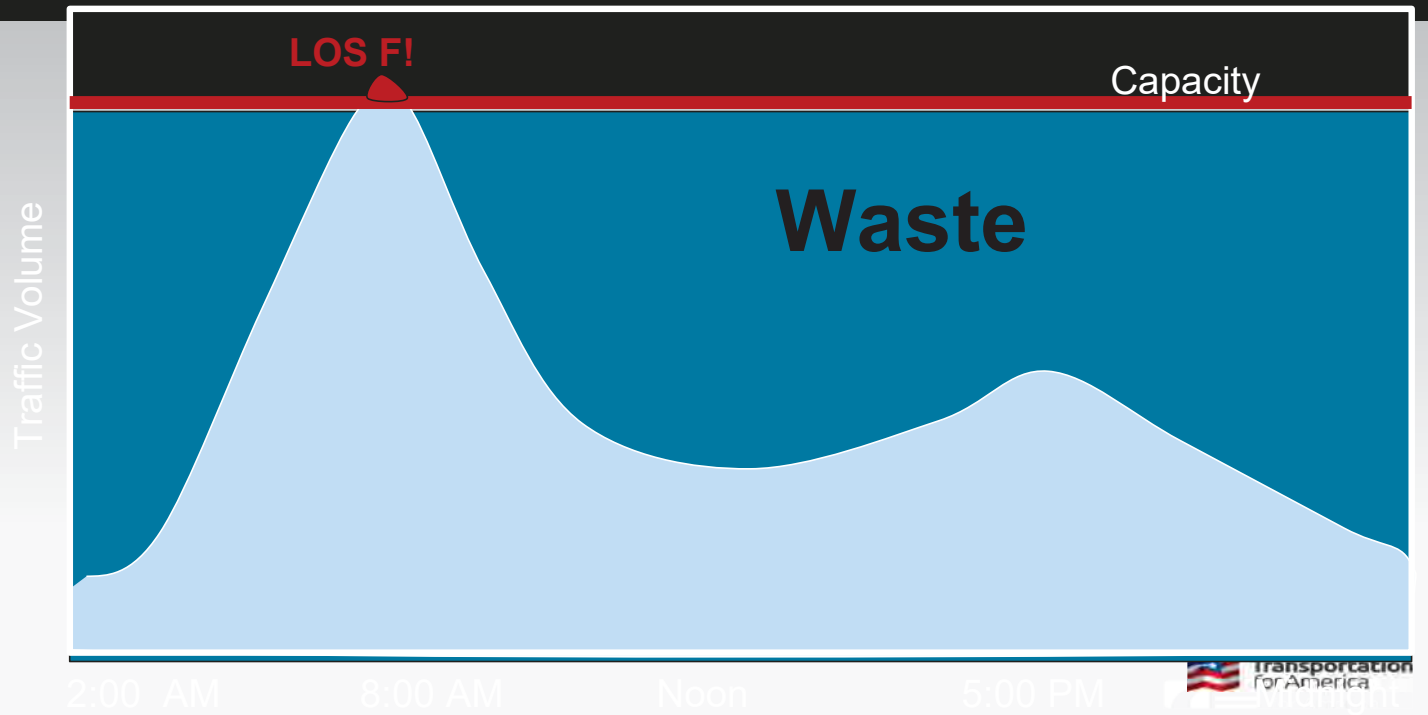

Transportation Economics



Traffic engineer:

F

A

Economist:

A

F

Designing for vehicle flow

LOS	Control Delay Per Vehicle (seconds)
A	≤ 10
B	>10 and ≤ 20
C	>20 and ≤ 35
D	>35 and ≤ 55
E	>55 and ≤ 80
F	>80

Table 6-3, Level of Service from Control Delay (2000 HCM)

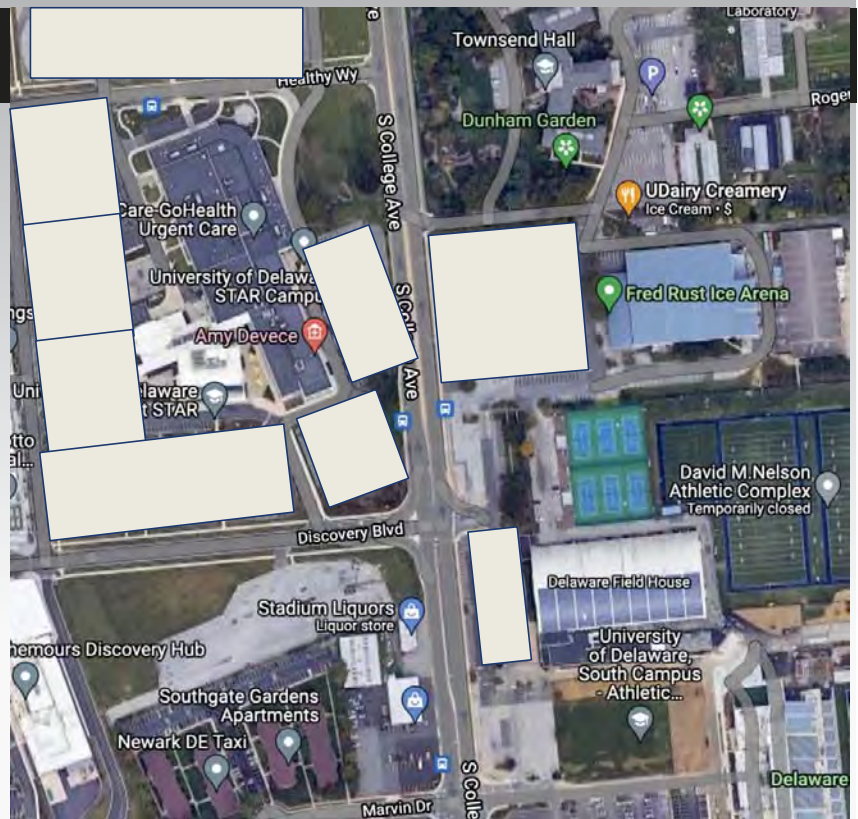

Freeway capacity grew faster than population, yet delay exploded



Change in freeway lane-miles, population growth, and annual hours of delay in the largest 100 urbanized areas from 1993-2017. Delay is defined as extra time spent traveling at congested rather than free-flow speeds. While FHWA only provides data on lane-miles of freeway, TTI's delay metrics capture both freeways and arterial roads.



Transportation and Development



Clustered development allows drivers to take fewer, shorter trips



Sprawling development requires drivers to take more longer trips



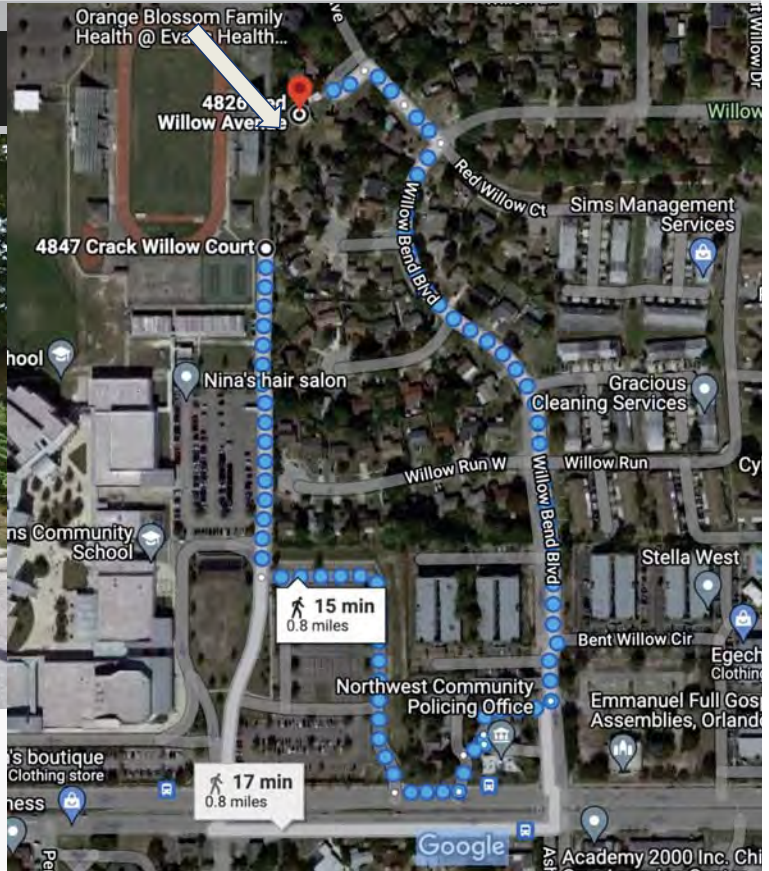
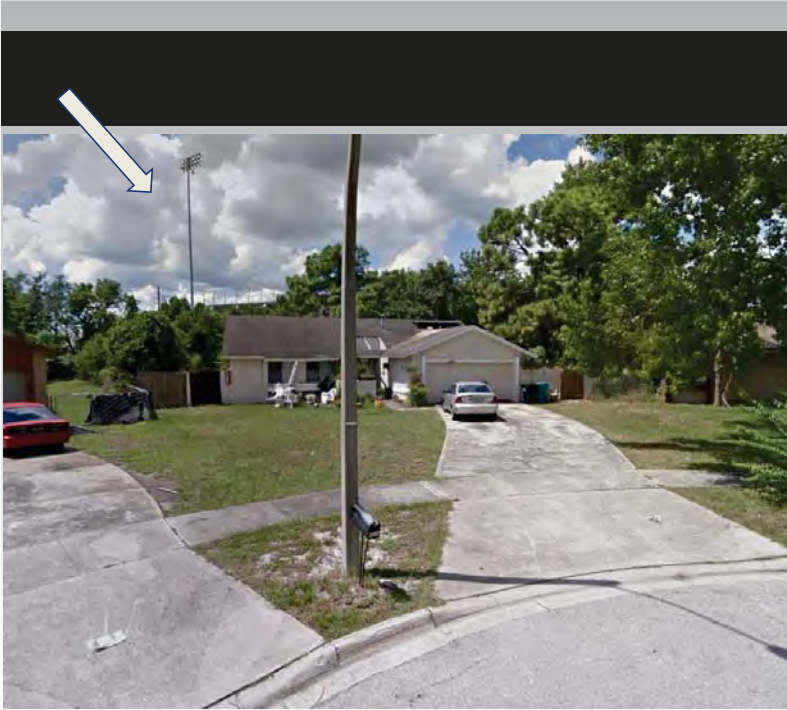

More people must drive, more congestion.

Miles driven per person grew by 20 percent in the largest 100 urbanized areas

1993 - 21 miles per day



2017 - **25** miles per day



Housing + Transportation Affordability

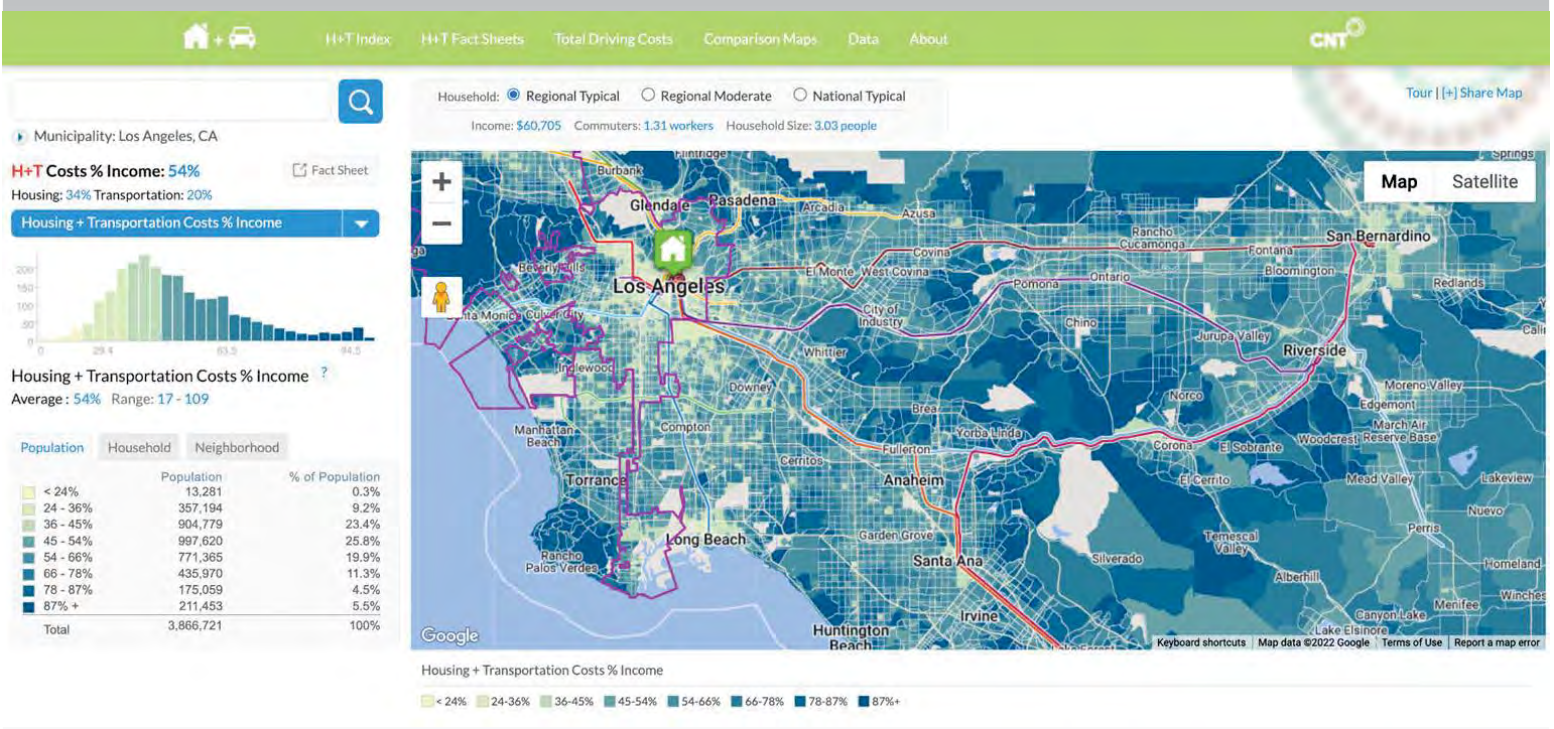

Other Factors

- Land use rules from the 1920s (single family zoning, set backs, height restrictions, separated land uses, parking minimums, etc).
- Housing supply and housing stock not connected to population.
- Neighborhood defenders, NIMBYism.

Non-conforming



Where is the infrastructure bill money going? (in billions)

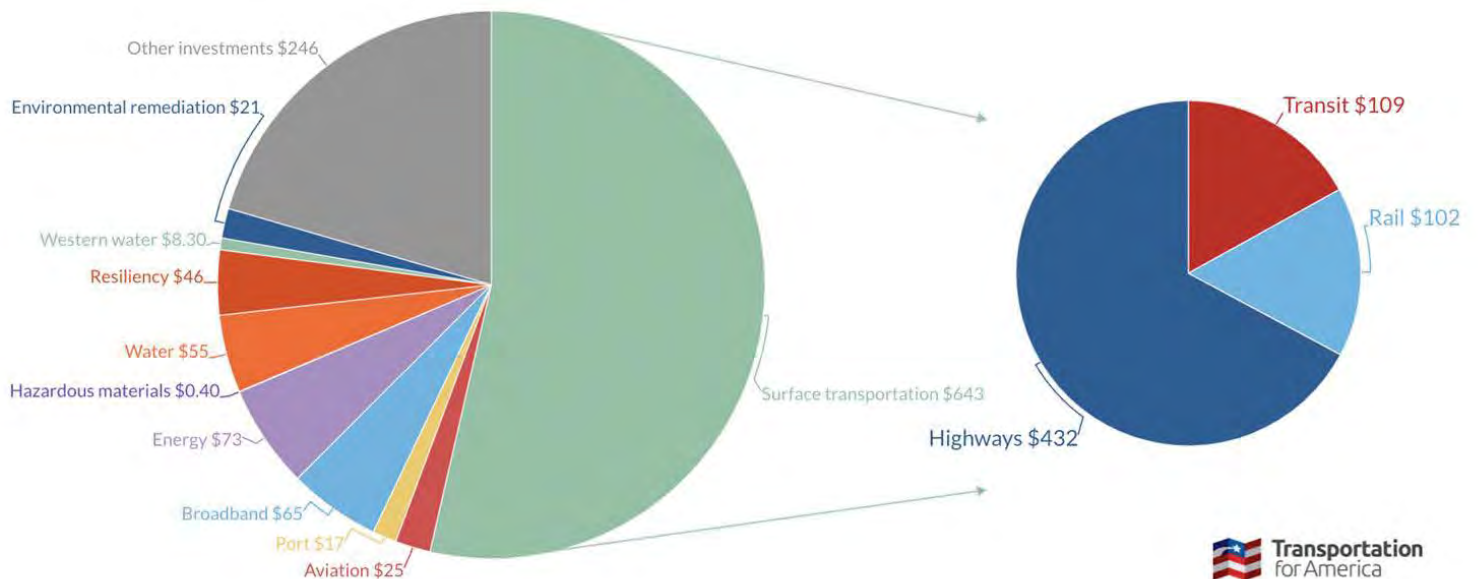

Where are highway trust fund dollars going?

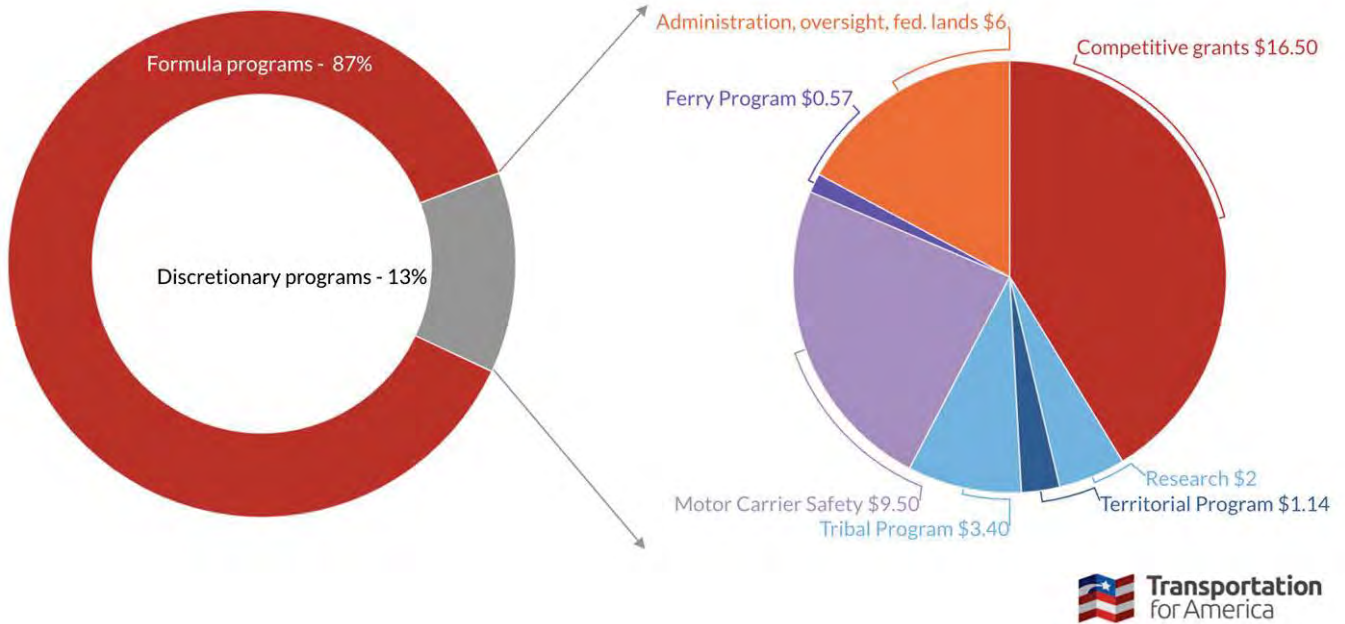

Highway trust fund formula programs (by percentage)

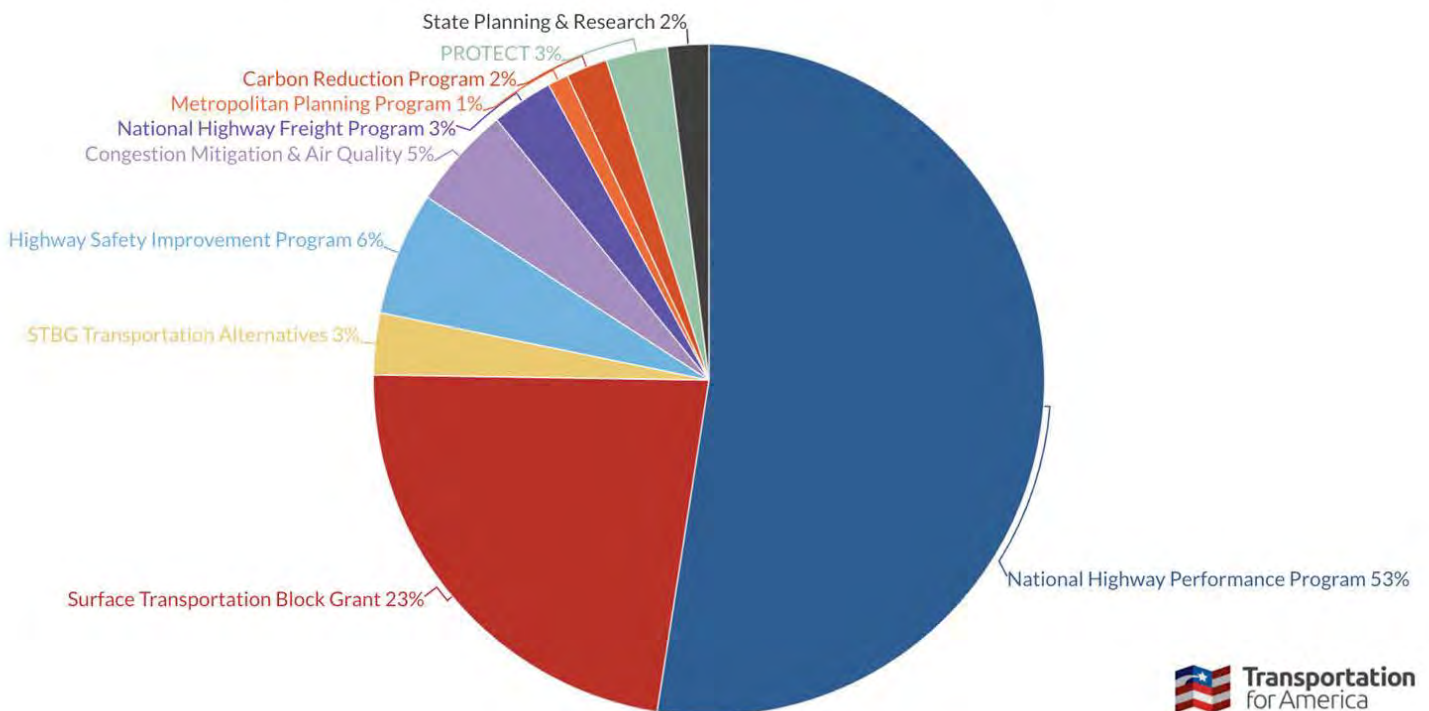

U.S. APPROACH TO ROAD SAFETY



RCP at a glance

Remove Retrofit Mitigate Replace

Eligible facilities: Highways or other facilities that create barriers to communities (specifically meant to include railroads, transit lines, and airports).

Fiscal Year	2022	2023	2024	2025	2026	5-Year Total
Planning	\$50M	\$50M	\$50M	\$50M	\$50M	\$250M
Capital Construction	\$145M	\$148M	\$150M	\$152M	\$155M	\$750M
Total Authorized Amount	\$195M	\$198M	\$200M	\$202M	\$205M	\$1,000M

Neighborhood Access and Equity Program

Within the Inflation Reduction Act (enacted 8/16/22)

\$3 billion aimed at projects that:

- Create mobility choices (except roadway expansion for SOV),
- Reduce barriers to mobility,
- Mitigate damaging physical and environmental impacts to communities.



1/3 of funding aimed at distressed communities (100% federal cost share)



Reconnecting Communities eligible

1. Most formula programs
 - a. National Highway Performance Program
 - b. Surface Transportation Block Grants
 - c. Congestion Mitigation and Air Quality Improvement
 - d. Carbon Reduction Program
 - e. Transportation Alternatives Program
2. RAISE - Rochester used this
3. Congestion Relief Program



West Side Highway, NYC



Transportation
for America

West Side Highway, NYC



Transportation
for America

Greenville, SC



Greenville, SC

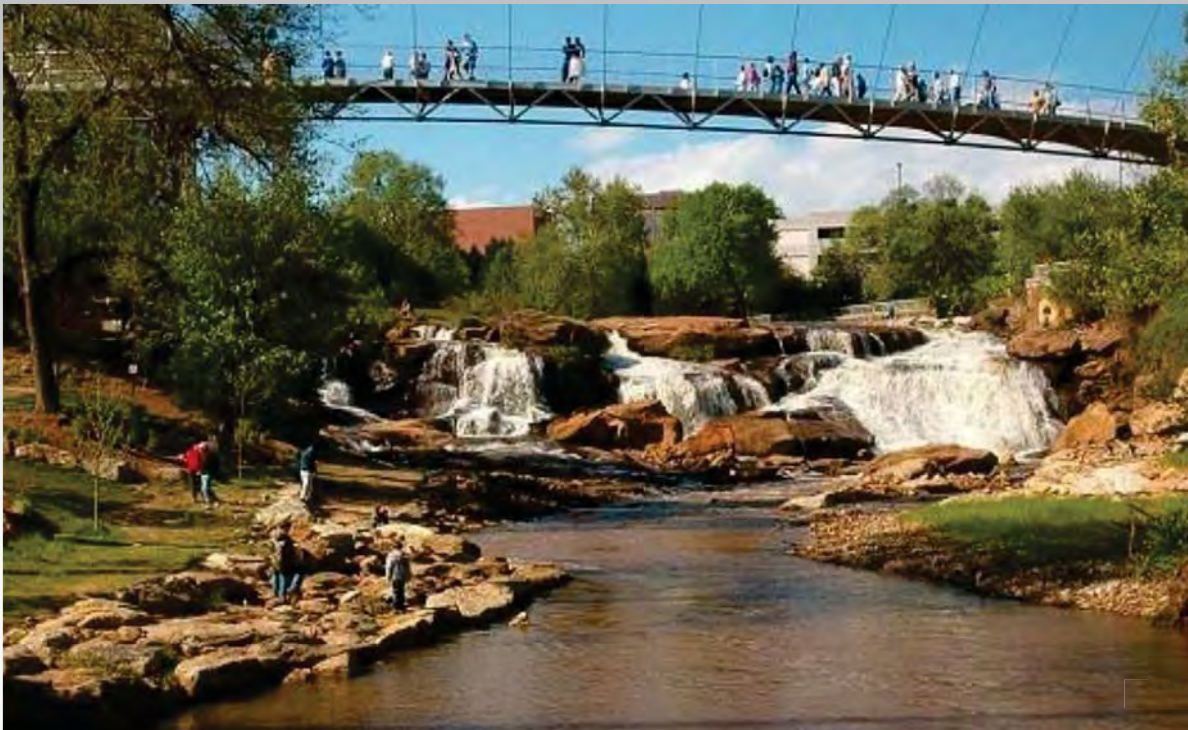

Complete Streets

Learn how we are creating a system that enables safe, convenient access for all types of transportation options - walking, biking, driving and riding transit.

A transportation system that accommodates all forms of transportation is more efficient in the travel space provided, more accessible, safer, more economical and sustainable.

Complete Streets is an approach to planning, designing, building, operating and maintaining the transportation system that enables safe and convenient access to destinations for all people, including pedestrians, bicyclists, motorists and transit riders. It uses a set of tools or treatments that create a more balanced and resilient transportation system.

In 2022, the Washington State Legislature passed [Senate Bill 5974 \(PDF 738KB\)](#), the Move Ahead Washington package. It included a Complete Streets requirement added to [RCW 47.24.060](#), which directs that "in order to improve the safety, mobility and accessibility of state highways, it is the intent of the Legislature that the department must incorporate the principles of complete streets with facilities that provide street access with all users in mind, including pedestrians, bicyclists and public transportation users" for "state transportation projects starting design on or after July 1, 2022 and that are \$500,000 or more."



Visual examples of Complete Streets - All depict roads that have separated bicyclist and pedestrian facilities. The first image is a linear segment (in Port Townsend), the second (in Walla Walla) and third (in Bothell) are aerial views of a round about and signalized intersection.



Florida DOT



FIGURE 5 FDOT CONTEXT CLASSIFICATIONS



Multimodal access to destinations

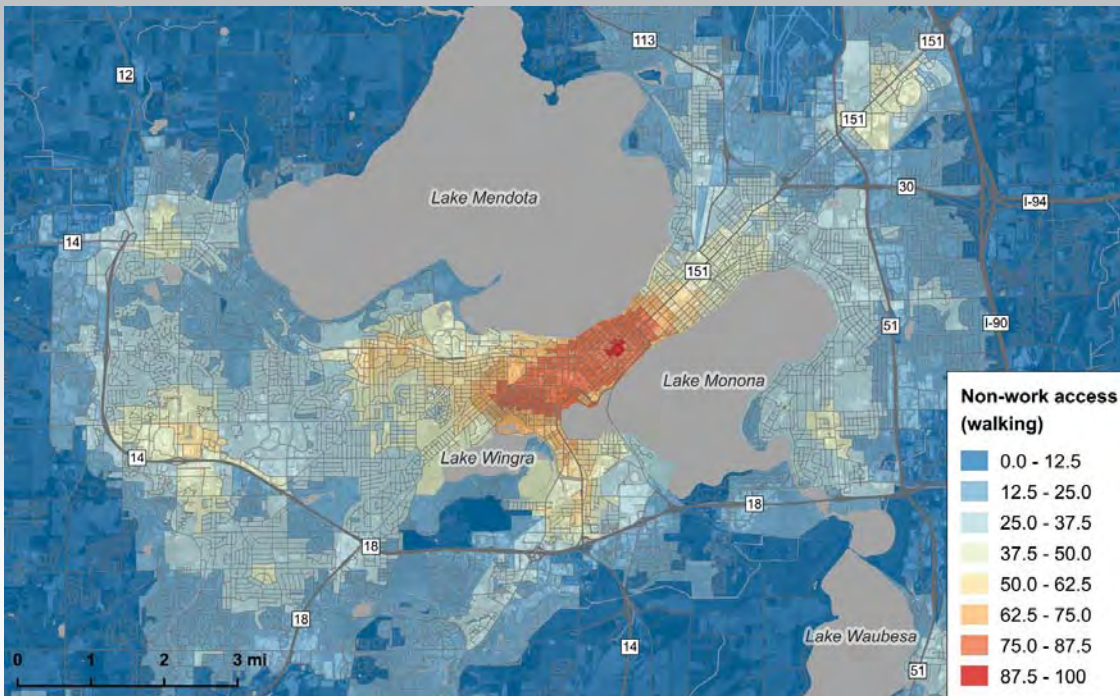

Access to:

- Schools
- Shopping
- Entertainment
- Grocery stores
- Food and drink
- Recreation
- Healthcare
- Public services
- Banks and ATMs

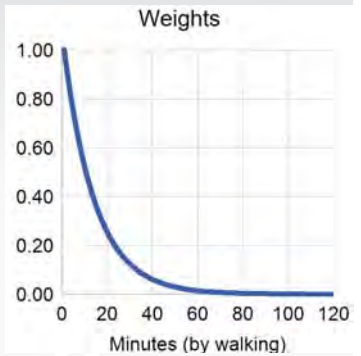

47

5.5 SMART SCALE SCORE	#83 OF 433 STATEWIDE	SMART SCALE Requested Funds..... \$52,900,000												
	#9 OF 39 DISTRICTWIDE	Total Project Cost..... \$90,765,000												
		Project Benefit..... 29.0												
		Project Benefit / Total Cost..... 3.2												
SMART SCALE Area Type A														
Factor	Congestion Mitigation		Safety		Accessibility			Economic Development			Environment		Land Use	
Measure	Increase in Peak Period Person Throughput	Reduction in Peak Period Delay	Reduction in Fatal and Injury Crashes	Reduction in Fatal and Injury Crash Rate	Increase in Access to Jobs	Increase in Access to Jobs for Disadvantaged Populations	Increase in Access to Multimodal Travel Choices	Square Feet of Commercial/Industrial Development Supported	Tons of Goods Impacted	Improvement to Travel Time Reliability	Potential to Improve Air Quality	Other Factor Values Scaled by Potential Acreage Impacted	Support of Transportation-Efficient Land Use	Increase Transportation-Efficient Land Use
Measure Value	1,236.1 persons	67.5 person hrs.	10.9 EPDO	4.4 EPDO / 100M VMT	69.8 jobs per resident	61.0 jobs per resident	6,180.5 adjusted users	8,261,999.0 thousand adj. sq. ft.	0.0 thousand adj. daily tons	852,986.9 adj. buffer time index	6,180.5 adjusted points	22.5 scaled points	1,324,959.0 access + pop/emp density.h	353,065.4 access + pop/emp density change.
Normalized Measure Value (0-100)	4.4	1.0	3.1	0.0	1.2	1.1	22.1	42.1	0.0	0.0	43.6	68.1	100.0	100.0
Measure Weight (% of Factor)	0.5	0.5	1.0	0.0	0.6	0.2	0.2	0.6	0.2	0.2	0.5	0.5	0.7	0.3
Factor Value	2.7		3.1		5.4			25.2			55.9		100.0	
Factor Weight (% of Project Score)	45%		5%		15%			5%			10%		20%	
Weighted Factor Value	1.2		0.2		0.8			1.3			5.6		20.0	
Project Benefit	29.0													
SMART SCALE Cost	\$52,900,000													
SMART SCALE Score (Project Benefit per \$10M SMART SCALE Cost)	5.5													

Connect with Transportation for America



www.t4america.org



@t4america



@transportationforamerica



T4America